

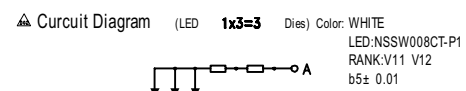

AMG12864P-G

Unmarked tolerance ± 0.3

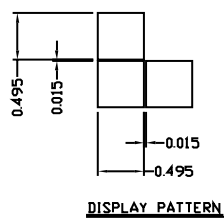
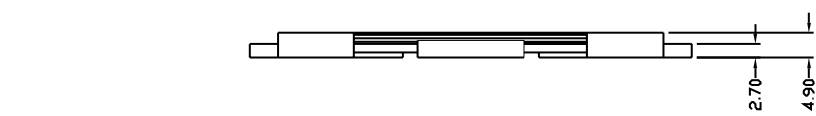
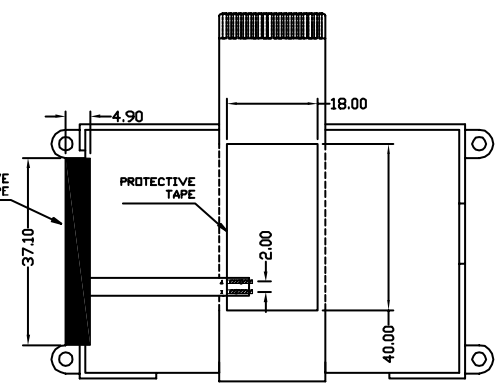
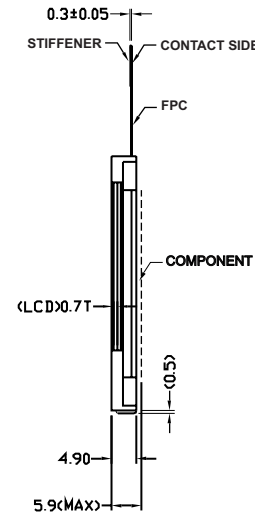
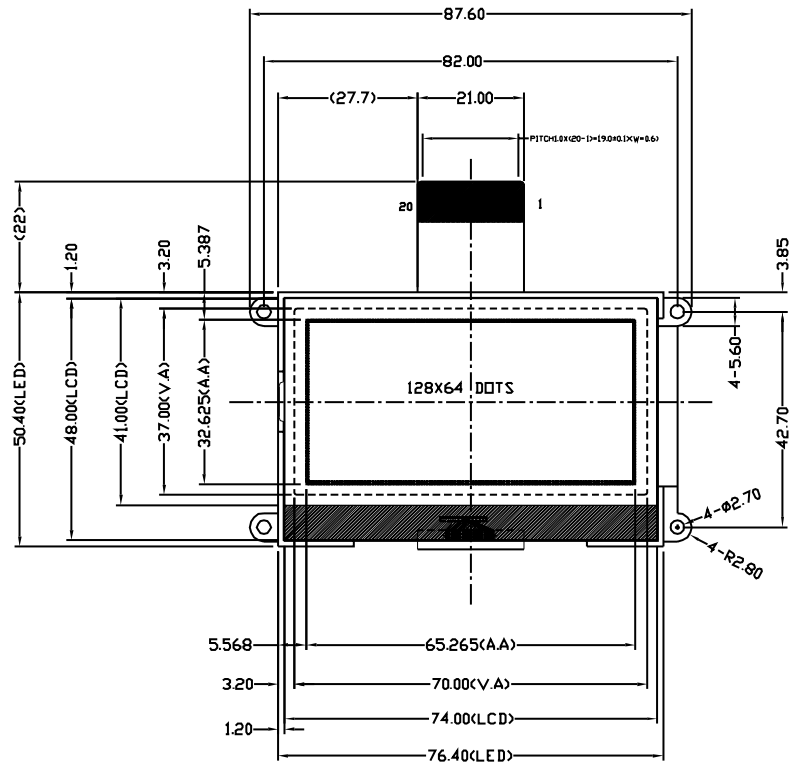

△ The Luminosity of the Display 24cd/m2 (typical)

BLOCK DIAGRAM

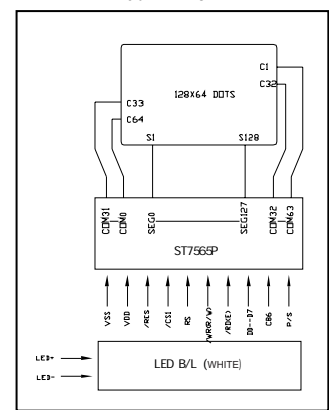

Pin No	Symbol	Pin No	Symbol
1	VSS	11	DB2
2	VDD	12	DB3
3	NC	13	DB4
4	/RES	14	DB5
5	/CS1	15	DB6
6	RS	16	DB7
7	/WR(R/W)	17	C86
8	/RD(E)	18	P/S
9	DB0	19	LED+
10	DB1	20	LED-